

SCHOOL CHOICE WORD SEARCH



Can you find these words in the puzzle below?

CELEBRATE
CHOICE
EDUCATION
LEARN

SCHOOL
STUDENT
TEACHER



SCHOOL CHOICE CLASSMATE QUIZ



Write the name of a classmate to complete each sentence.

_____ has brown eyes.

_____ is a good artist.

_____ has a dog.

_____ wears glasses.

_____ likes math.

_____ was born in January.

_____ likes vegetables.

_____ has a cat.

_____ made their bed this morning.

_____ likes pizza.



_____ is left-handed.

SCHOOL CHOICE MAZE

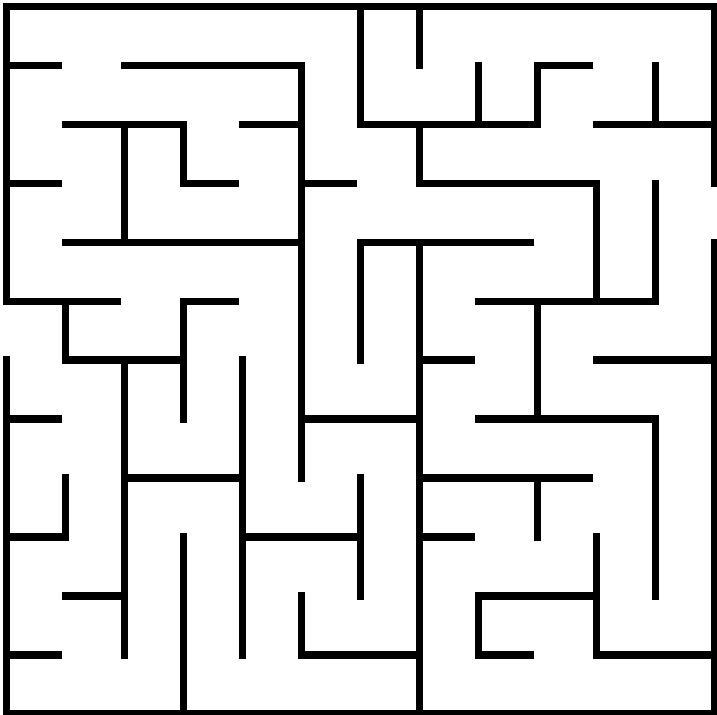

Can you help the student get to school on time?

START →



FINISH!



The maze is a square grid with a complex path of walls. The start is on the left side, and the finish is on the right side, represented by a school building icon.

SCHOOL CHOICE WORD SEARCH



Can you find these words in the puzzle below?

SCHOOL
MOM
DAD

STUDENT
BOOK
LEARN

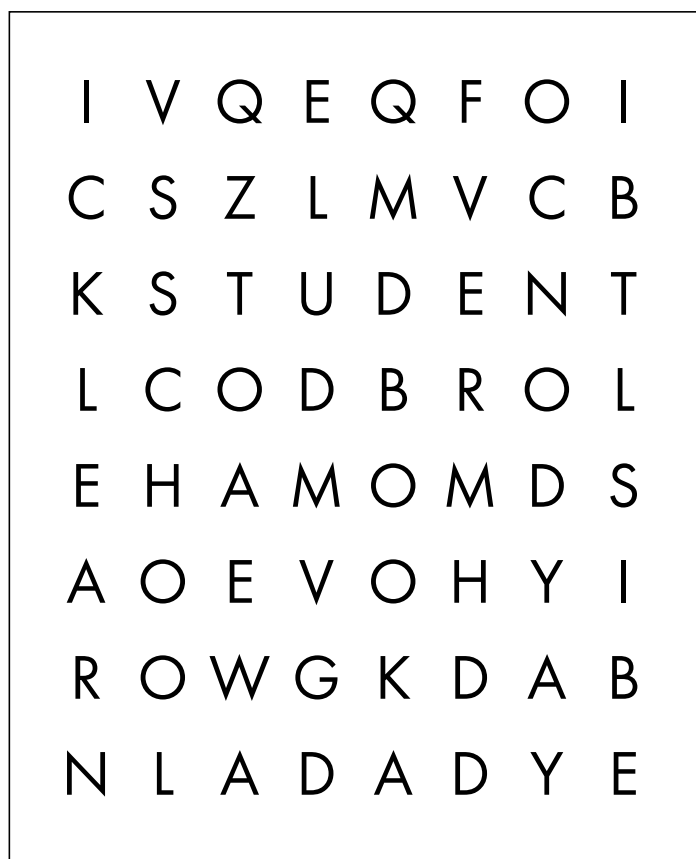

SCHOOL CHOICE CROSSWORD PUZZLE



Use the clues below to fill in the crossword puzzle!

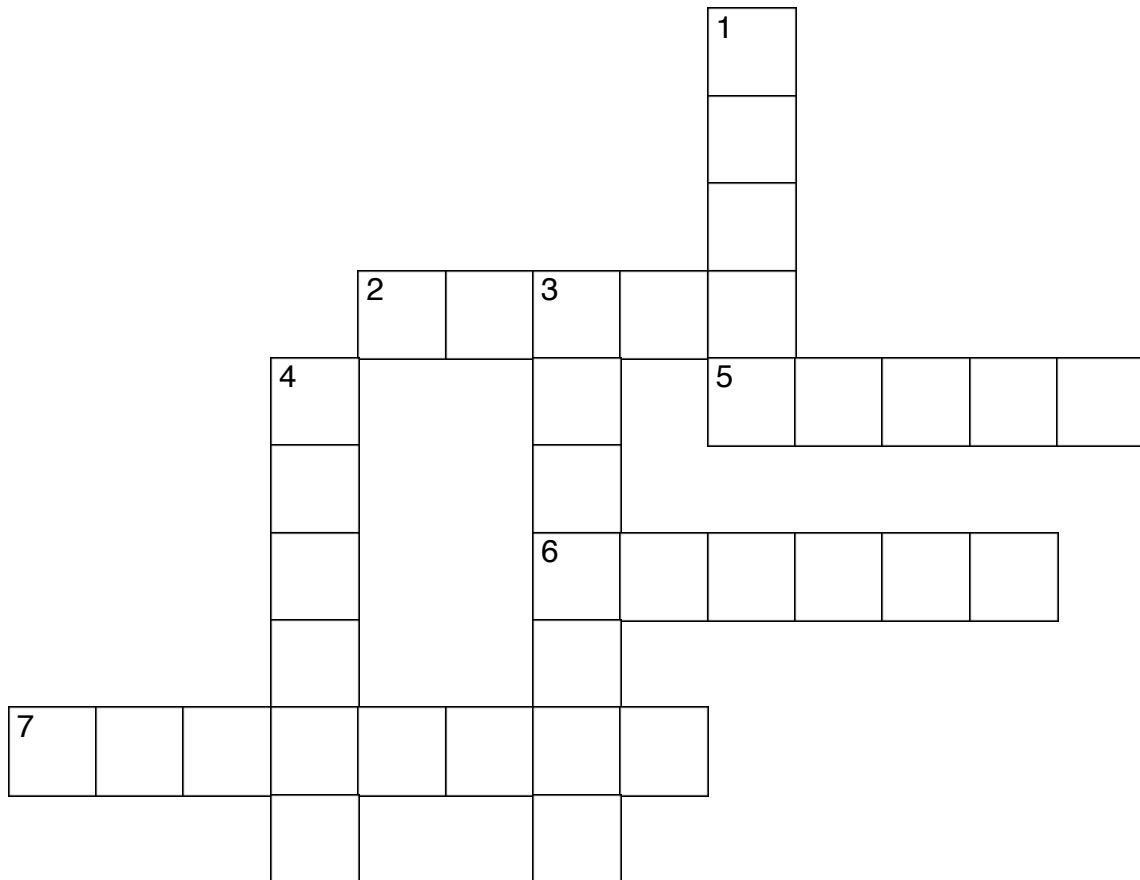

ACROSS

2. Not true
5. Will make a straight line
6. Time to go out and play
7. Turn this in on time

DOWN

1. Something to write on
3. A place where books are shelved
4. On the end of your pencil

SCHOOL CHOICE CONNECT THE DOTS

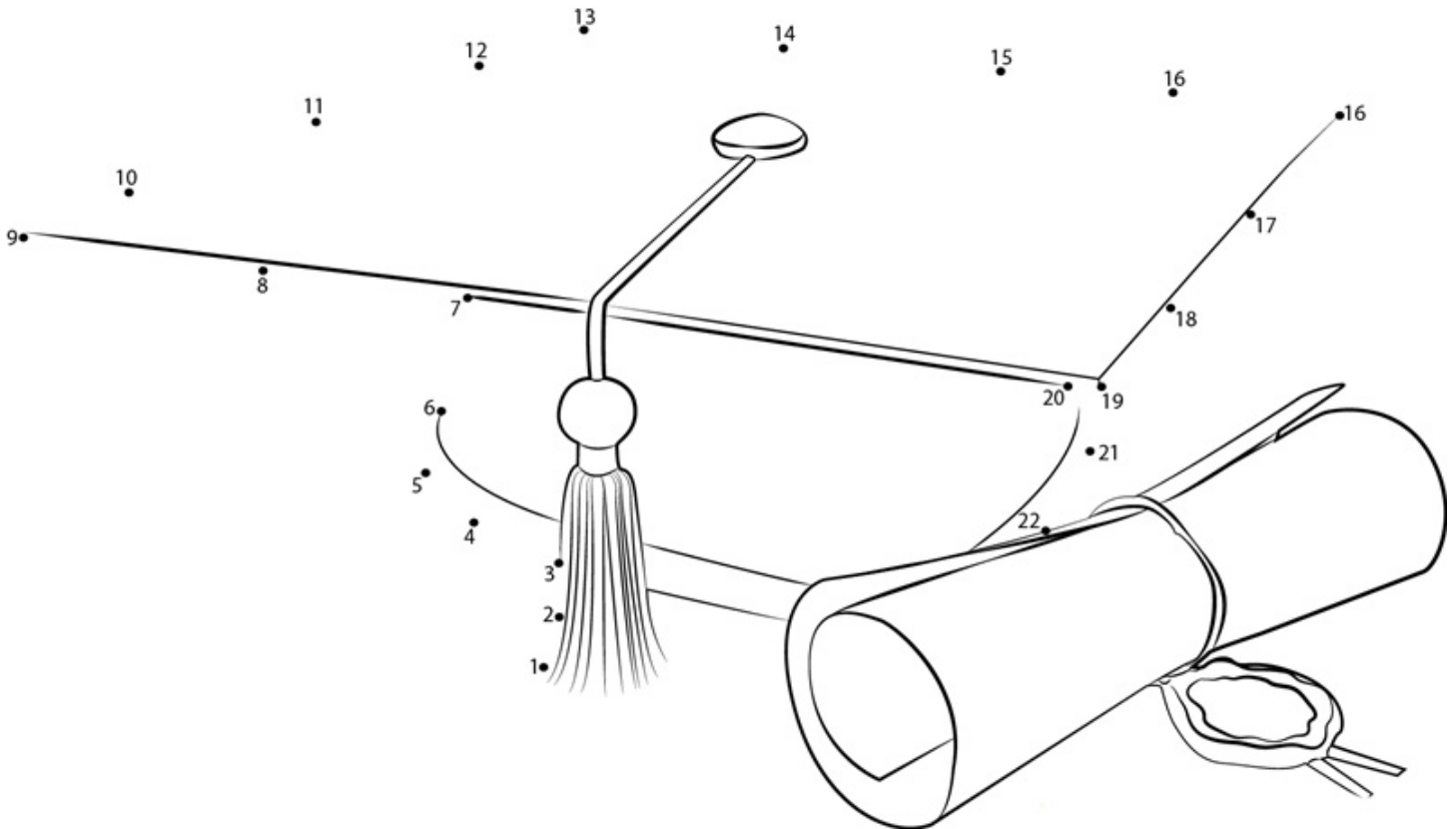

HELD EVERY JANUARY, NATIONAL SCHOOL CHOICE WEEK SHINES A SPOTLIGHT
ON EFFECTIVE EDUCATION OPTIONS FOR EVERY CHILD.
WWW.SCHOOLCHOICEWEEK.COM

SCHOOL CHOICE DOOR DECORATIONS



Color the picture, cut it out, and use it to decorate your classroom door or bulletin board.



**HELD EVERY JANUARY, NATIONAL SCHOOL CHOICE WEEK SHINES A SPOTLIGHT
ON EFFECTIVE EDUCATION OPTIONS FOR EVERY CHILD.
WWW.SCHOOLCHOICEWEEK.COM**

SCHOOL CHOICE COLORING SHEET

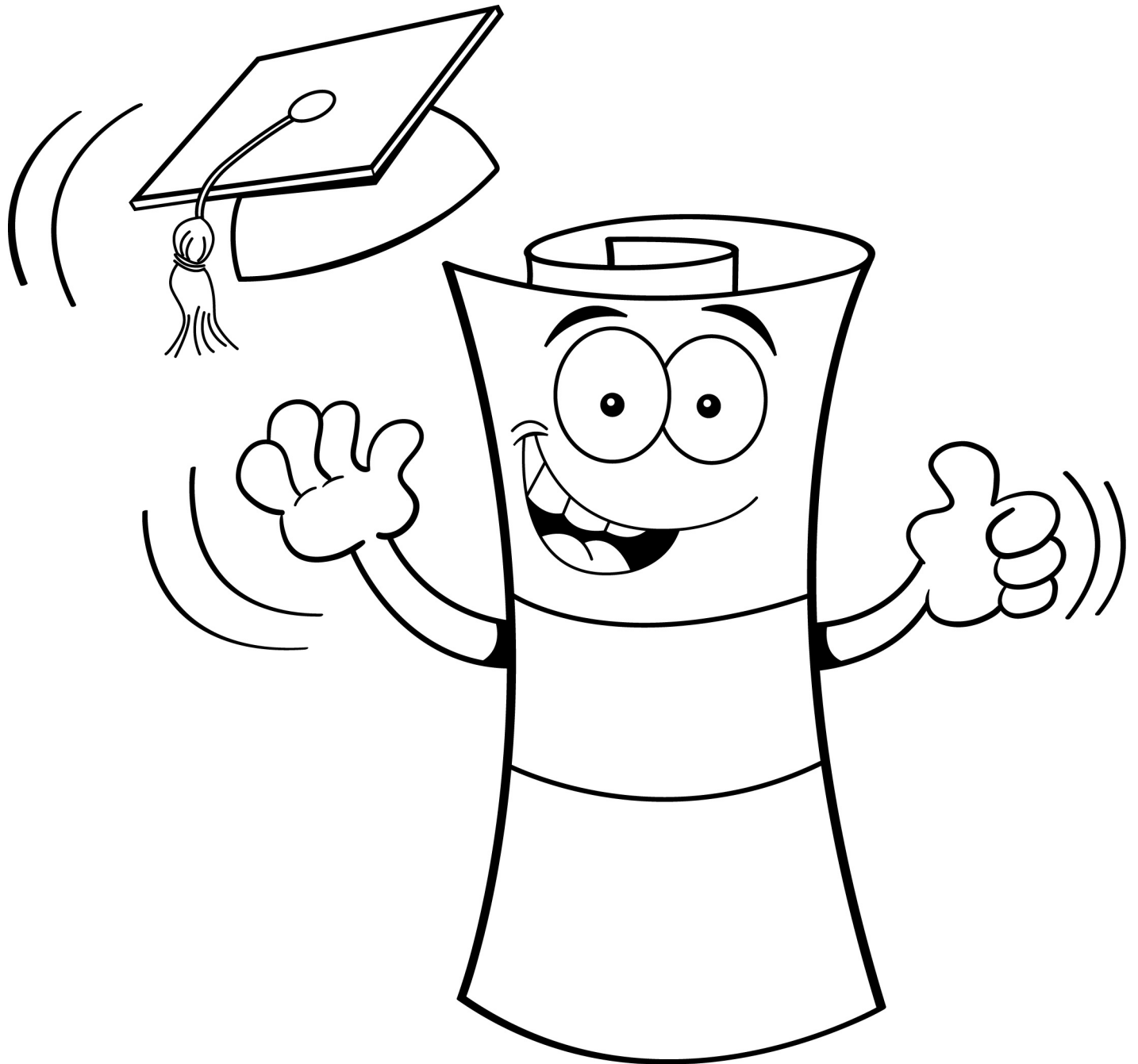

HELD EVERY JANUARY, NATIONAL SCHOOL CHOICE WEEK SHINES A SPOTLIGHT
ON EFFECTIVE EDUCATION OPTIONS FOR EVERY CHILD.
WWW.SCHOOLCHOICEWEEK.COM

SCHOOL CHOICE DOOR DECORATIONS



Color the picture, cut it out, and use it to decorate your classroom door or bulletin board.

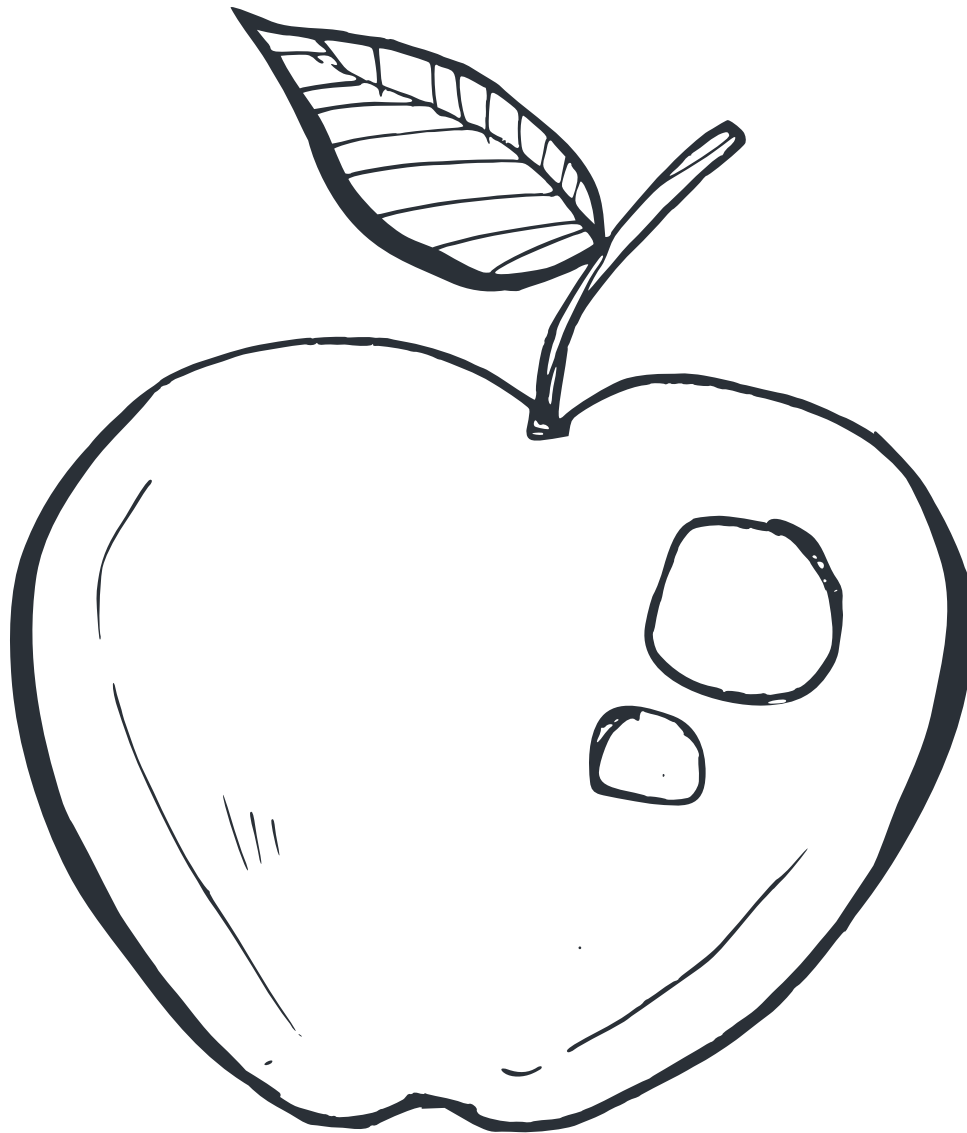

SCHOOL CHOICE DOOR DECORATIONS



Color the picture, cut it out, and use it to decorate your classroom door or bulletin board.



HELD EVERY JANUARY, NATIONAL SCHOOL CHOICE WEEK SHINES A SPOTLIGHT
ON EFFECTIVE EDUCATION OPTIONS FOR EVERY CHILD.
WWW.SCHOOLCHOICEWEEK.COM

SCHOOL CHOICE DOOR DECORATIONS



Color the picture, cut it out, and use it to decorate your classroom door or bulletin board.

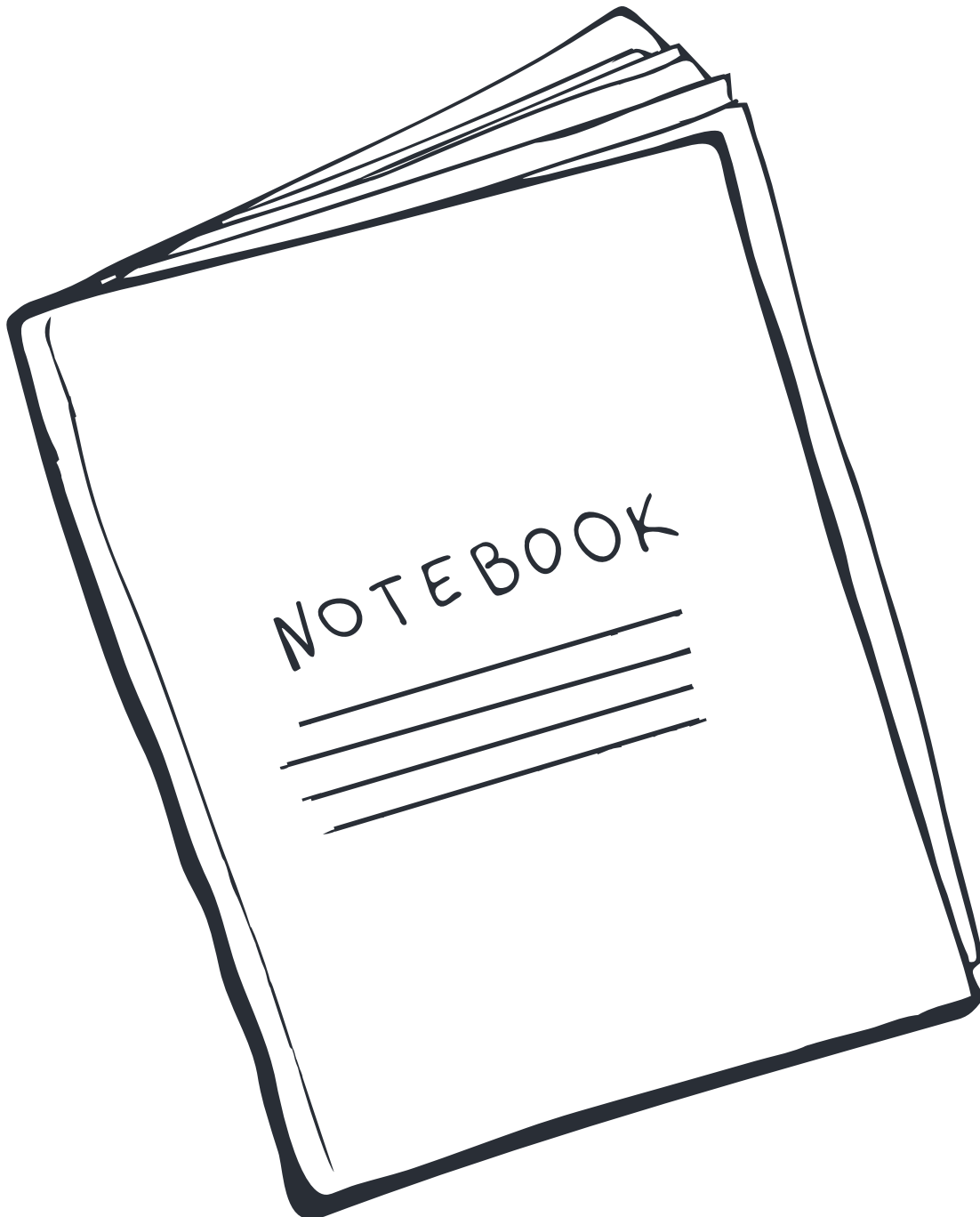

HELD EVERY JANUARY, NATIONAL SCHOOL CHOICE WEEK SHINES A SPOTLIGHT
ON EFFECTIVE EDUCATION OPTIONS FOR EVERY CHILD.
WWW.SCHOOLCHOICEWEEK.COM

SCHOOL CHOICE DOOR DECORATIONS



Color the picture, cut it out, and use it to decorate your classroom door or bulletin board.

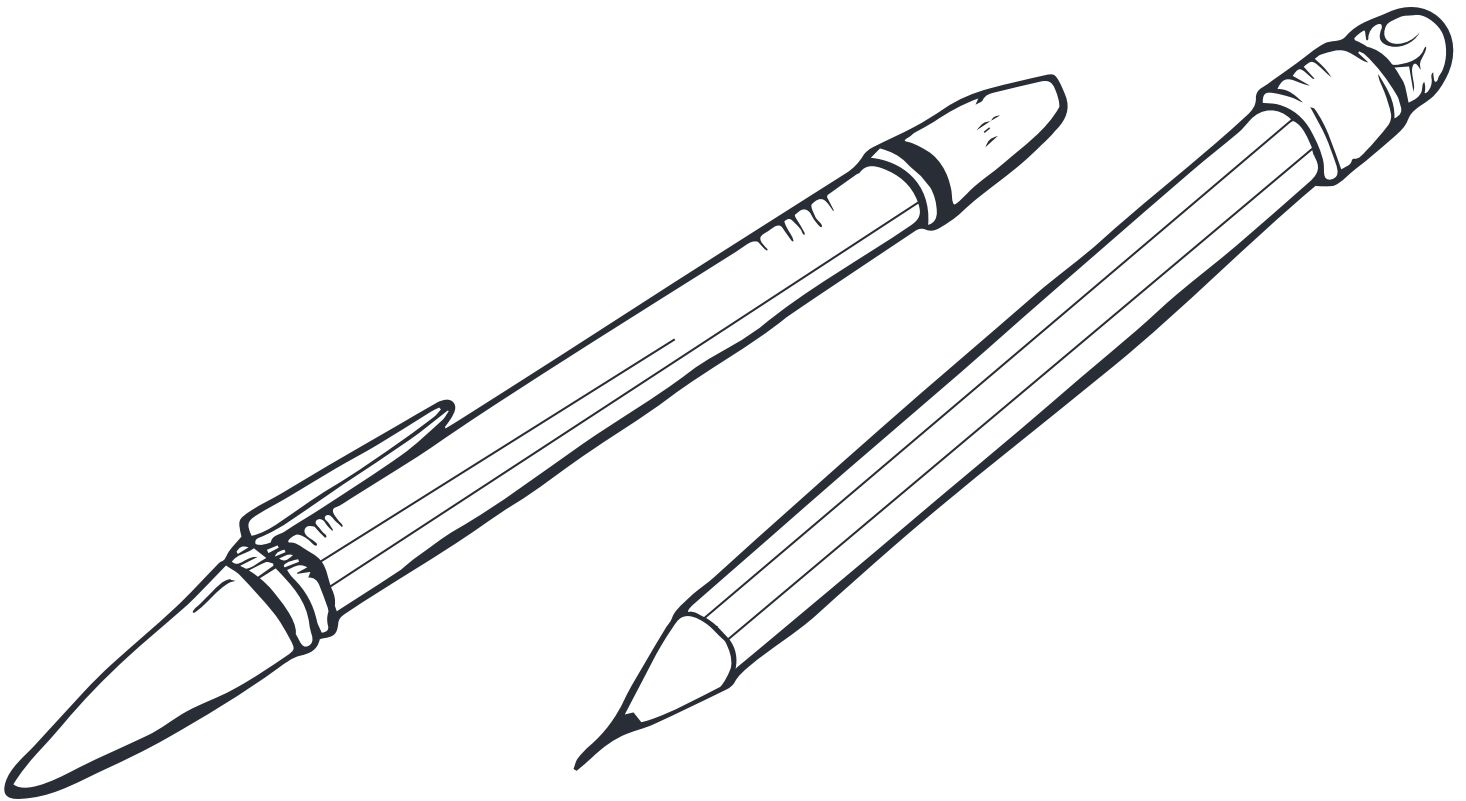

SCHOOL CHOICE DOOR DECORATIONS



Color the picture, cut it out, and use it to decorate your classroom door or bulletin board.

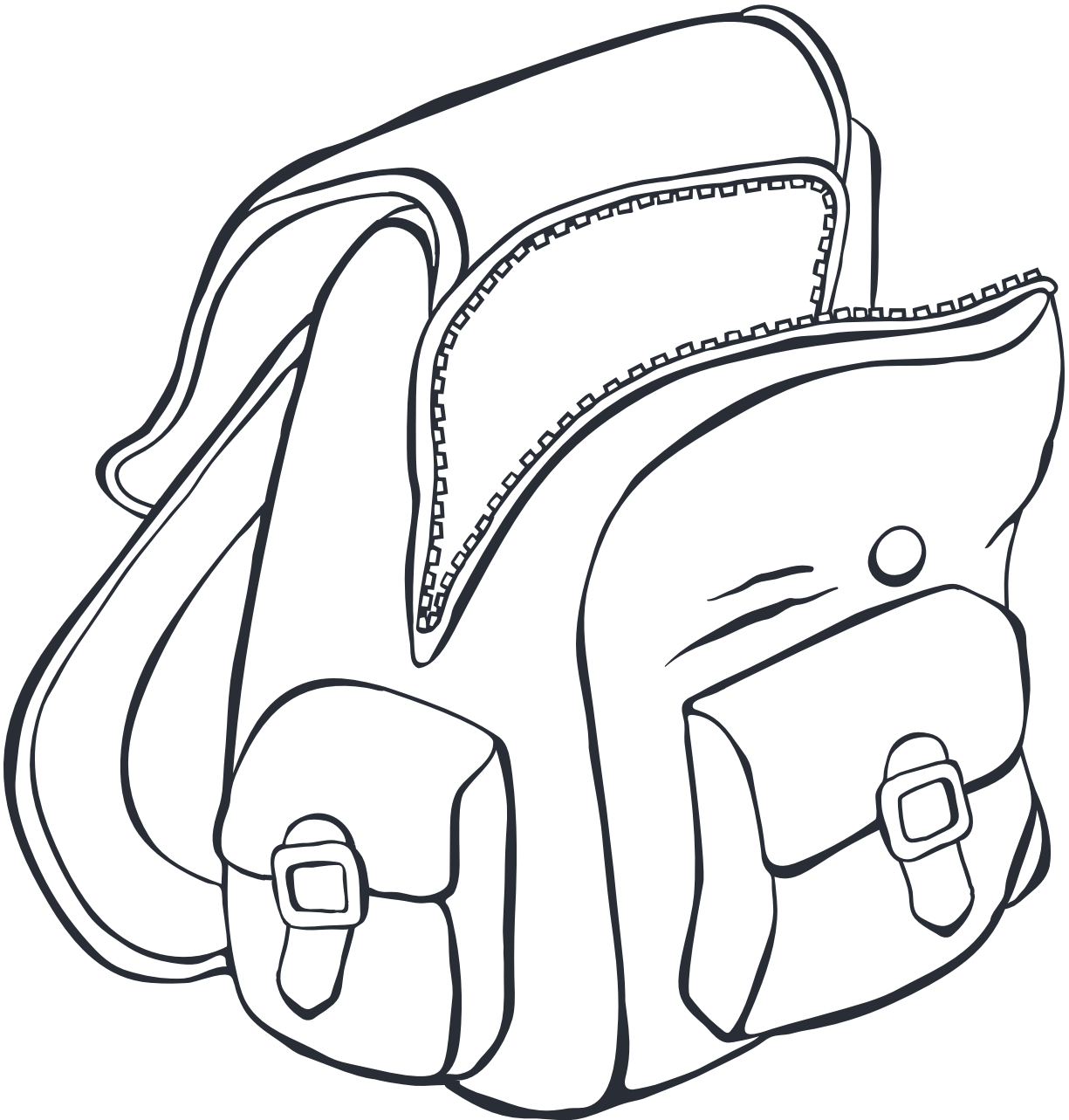

SCHOOL CHOICE DOOR DECORATIONS



Color the picture, cut it out, and use it to decorate your classroom door or bulletin board.

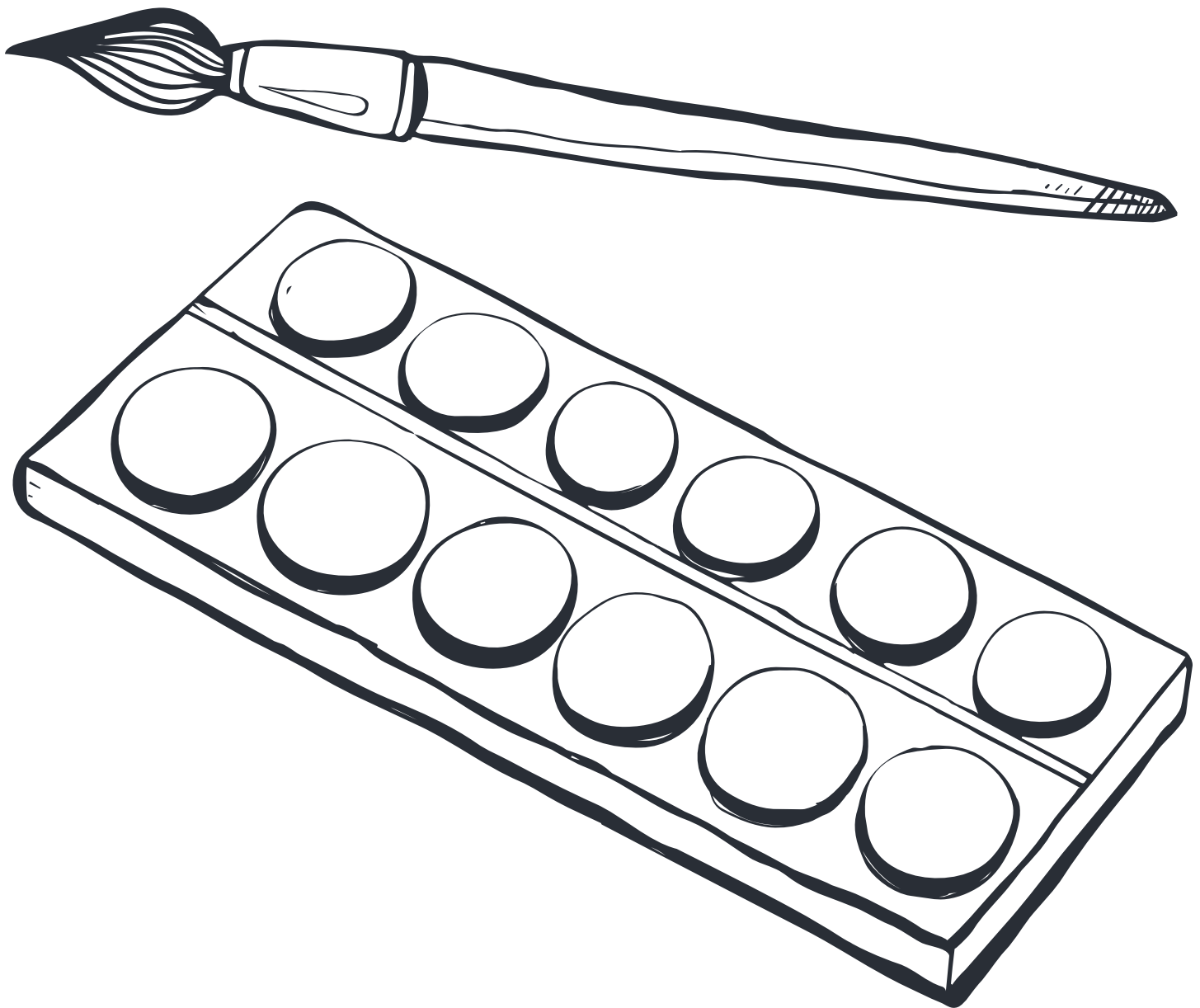

HELD EVERY JANUARY, NATIONAL SCHOOL CHOICE WEEK SHINES A SPOTLIGHT
ON EFFECTIVE EDUCATION OPTIONS FOR EVERY CHILD.
WWW.SCHOOLCHOICEWEEK.COM

SCHOOL CHOICE DOOR DECORATIONS



Color the picture, cut it out, and use it to decorate your classroom door or bulletin board.



SCHOOL CHOICE DOOR DECORATIONS



Color the picture, cut it out, and use it to decorate your classroom door or bulletin board.



HELD EVERY JANUARY, NATIONAL SCHOOL CHOICE WEEK SHINES A SPOTLIGHT
ON EFFECTIVE EDUCATION OPTIONS FOR EVERY CHILD.
WWW.SCHOOLCHOICEWEEK.COM